

HD DECK®

DUAL
DWT

A Composite Prime Product

Natural Wood Grain Composite Decking



HD DECK® **DUAL**
A Composite Prime Product



HD Deck® Dual is our most natural looking wood plastic composite deck. With its 'capped' design creating a protective layer that offers **maximum protection** against stains, fading and the elements for an extra long life, HD Deck® Dual takes composite decking to the next level.

The deck is made from **FSC® 100% hardwood flour** and **recycled plastic** which combine to produce a high quality finished product that outperforms traditional treated timber.



As featured in
Daily Mail

Dual-sided board #1

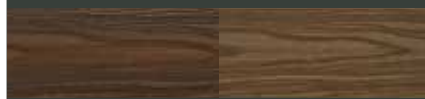

Side A - Walnut

Side B - Oak

Dual-sided board #2

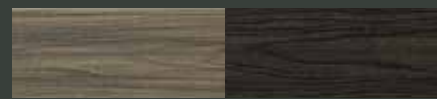

Side A - Antique

Side B - Carbon



Low Maintenance & Long Life

- Will not rot or decay
- Will not warp, bend or splinter
- Requires no staining, treating or painting



Socially Responsible & Friendly to the Environment

- FSC® 100% certified timber
- Recycled plastics
- Over 280 plastic milk bottles used per square metre



Safe & Child Friendly

- Barefoot safe
- Slip resistant
- Free from hazardous substances

HD Deck® Dual is double-sided, **two colours in one board!**

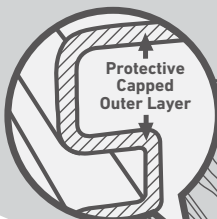
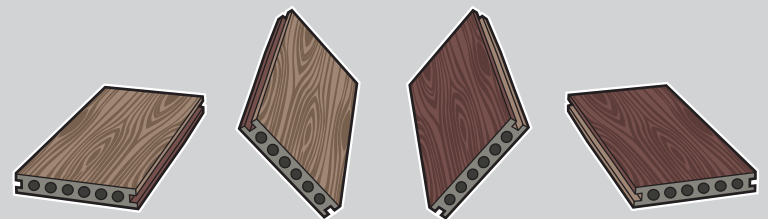

Board Dimension

22.5 x 143 x 3600mm

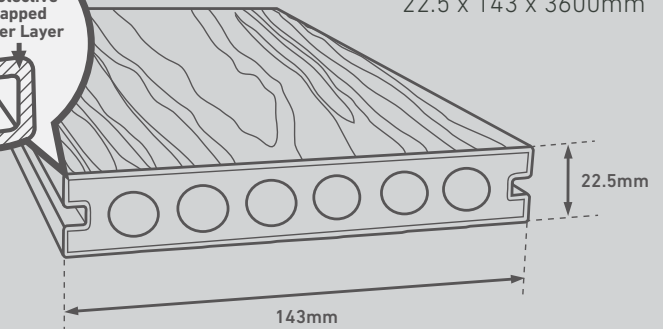

Our **secret clip system** ensures a clean finished install on your deck without the need for unsightly screws.



Starter Clip & Screw



Clip & Screw

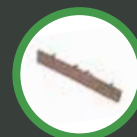

End Cap

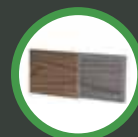

Fascia
72 x 11 x 3600mm



Composite Prime®
Naturally Evolved

www.composite-prime.com

